

Talyvel® 6 and Clinometers



For angular & level measurement, flatness,
parallelism, straightness & squareness

Talyvel® 6 electronic level

Fast, accurate, versatile and wireless

Universally accepted as the best in their field, Taylor Hobson's Talyvel® Electronic Level systems provide versatile and precise measurement for a wide variety of industrial applications.

They combine exceptionally high accuracy, unmatched stability and repeatability with fast response and operational convenience.



Incorporating a compact, highly stable, pendulum transducer in the Level Unit and interfacing directly to a tablet PC or laptop with dedicated software, Talyvel® 6 provides rapid and simple reading of angle of tilt and measurement relative to gravity. It is simple to calibrate and operate, with a fast measurement response time.

The Talyvel®'s Level Unit can be positioned remotely from the computer – for instance in hard to see or confined places with the computer located where it can be easily read. A wireless option is also available for increased flexibility.

Measurement results from the Talyvel® 6 system are displayed on the PC screen. In addition, results can be recorded and analysed further when using the optional Taylor Hobson analysis software.

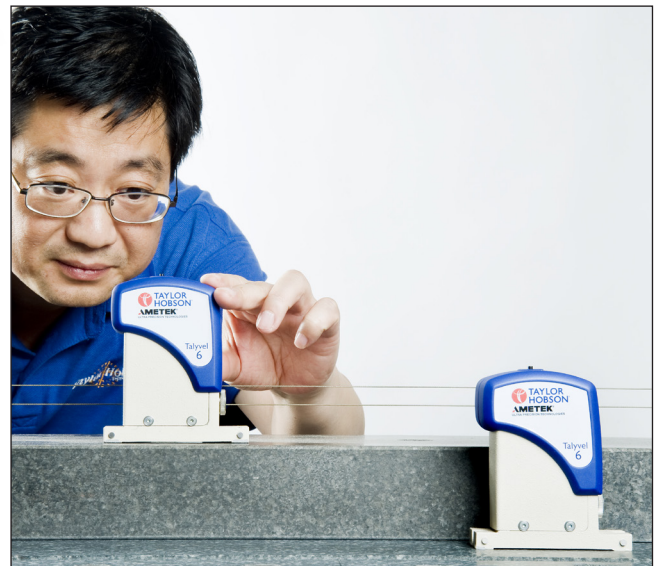

Applications

Civil engineering

- Remotely monitoring the tilt movement of structures
- Checking bridge arches for movement before and after construction
- Checking foundation settlement and levelling foundation pads
- Levelling radar, gyro and weapon platforms or large telescopes
- Checking level and straightness of rails

Machine tools

- Checking slideways for straightness and twist
- Checking columns for squareness to slideways
- Checking surface plates for flatness
- Monitoring the settlement of large machinery
- Measuring the camber on rolls
- Parallelism checking and setting

Marine engineering

- Checking the twist of marine engine bed plates
- Alignment of weapon mountings to reference platforms using differential mode
- Checking the parallelism of crankpins to main bearings on marine crankshafts



Talyvel® 6 offers



Wireless option with up to 10 metres range



Unmatched stability of measurements



Software in various languages (inc. Chinese & Japanese)



Intuitive touch screen software on tablet PC/laptop



Clear display of dynamic measurement value on screen



Wide range option available ± 2000 seconds



Quick, accurate and simple setting to gravity, or measurement of level



Unrivalled accuracy of 0.2 arc second over the centre measuring region



Fine ± 10 second range available (using the on-screen analogue meter)

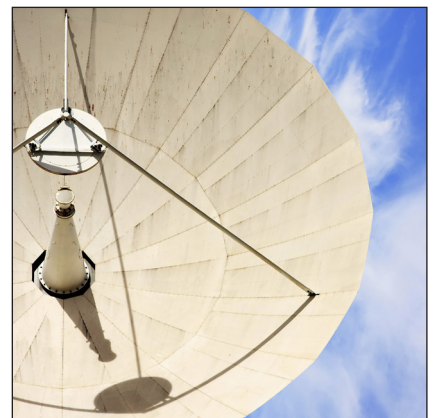
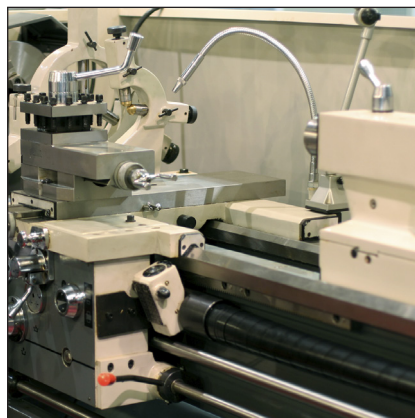
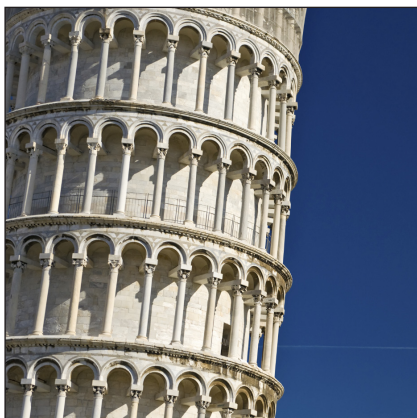

The Talyvel® instrument



Talyvel® 6 Standard System (Code M112-4515-01) Wide Range Talyvel® (Code M112-5056)

This compact unit offers stable, high accuracy measurement. Its pendulum type transducer is suspended on fine wires and is silicon oil damped to reduce the effects of mechanical vibration during measurements. Built-in electronics allow the Talyvel® level to interface directly to a PC using either the USB cable supplied or an optional wireless dongle. The level contains rechargeable batteries.

The Level Unit incorporates an On/Off clamp knob which, when screwed in, secures the pendulum during transport.



Talyvel® 6 Differential System (Code M112-4516-01) Wide Range Differential (Code M112-5057)

Two Level Units (A and B) can be controlled from the computer interface to provide a differential system for measuring the difference in inclination of two surfaces, as well as their departure from absolute level. Display of results from each Level Unit and their differential value are determined by selection of A, B or A-B.

The differential Talyvel® is of particular value in applications such as measuring the relative deflections in buildings, in the production and assembly of precision machinery where there may be vibration and for monitoring twist or deflection on moving surfaces, eg ship's engines or machinery on oil rig platforms.

The Talyvel® can also be supplied with **multiple levels** connected to one computer with dedicated software – particularly useful for monitoring level on large areas such as platforms or tables – price on application.

Connectivity options

1 20 metre USB extension (Code 112-5590)

This extension cable allows the Talyvel® to be used at longer distances (standard length cable is 3 metres).

2 Wireless Dongle Accessory (Code 112-4519)

The Talyvel® can be used in wireless mode with the addition of an optional dedicated wireless receiver which plugs into the computer USB port and has a range of up to 10 metres.

3 Remote keypad (Code 265-1277)

Small handheld keypad allows measurements to be taken away from the laptop over short range.

4 External Trigger (Code 112-5766)

This switch allows measurements to be triggered remotely when the level is being used far away from the laptop.

5 Digital Readout (Code 112-5765)

This hand-held digital readout is used for a simple readout without the need for the laptop. Ideal for simple levelling where measurements do not need to be saved or for use in awkward locations where it is not possible to use a laptop. Readout has a range of up to 15 metres.



Talyvel® 6 technical data

Measurement capability

	Standard option	Wide range option
Range	± 800 seconds	± 2000 seconds
Best accuracy	0.2 second	0.4 second
Accuracy over central 100s	± 1 second	± 2 second
Accuracy over full range	± 8 second	± 20 second
Resolution	0.01 seconds	0.1 seconds
Analogue software display	± 600 seconds range, switchable to "FINE" range of ± 10 seconds.	
Response time	Settling time of display 2 seconds	
Talyvel® battery life	Not less than 10 hours continuous use from fully charged state	
Working temperature	- 5°C to + 40°C	
Storage temperature (Instrument without batteries)	- 10°C to + 40°C	
Standard USB cable length	3 metres (9.8 feet)	
Power supply through PC	110V, 120V, 220V, 240V, 50/60Hz	

Technical

Overall dimensions of level unit	
Base	100 x 32 mm (3.94 x 1.25 in)
Height	115 mm (4.53 in)

Approx. weight	
Level unit	0.75 kg (1.65 lb)
Notebook / Tablet PC unit	2.0 kg (4.4 lb) approx. (model may vary)

Wireless accessory	
Frequency used	2.405 to 2.48 GHz band
Protocol used	MiWi™
Range	≤ 10 metres (32.8 feet)

Speed of measurement

Speed of measurement depends on the processing capability of the PC. Taylor Hobson supplies a (minimum) 1 GHz processor which has a speed of about 0.4 sec for a single measurement. This can be as small as 0.1 sec for faster (3 GHz processors). The facility to average a number of successive measurements is available to the user in order to (for example) eliminate any vibrations or other short term instabilities associated with the measurement set up.

UKAS Certification

Talyvel®'s can be supplied with a United Kingdom Accreditation Service (UKAS) certificate which gives an independent and authoritative traceable guarantee of instrument performance and accuracy. Regular servicing and UKAS calibration will guarantee that the performance specification is maintained.

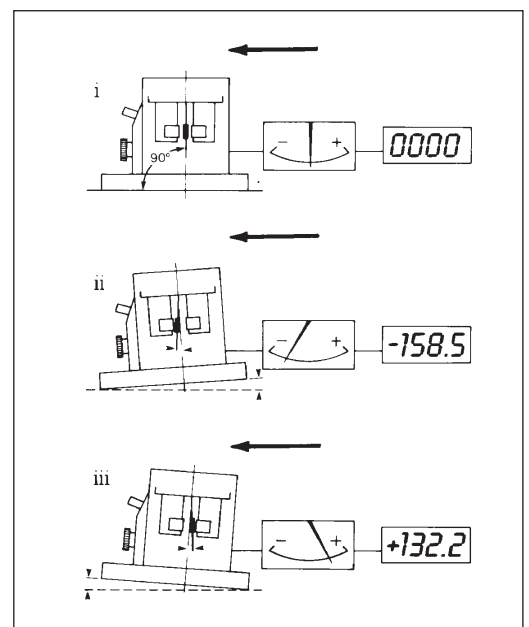

Meter and digital indication of Level Unit inclination

- (i) Level Unit Level - Zero inclination
- (ii) Level Unit inclined anti-clockwise - negative indication
- (iii) Level Unit inclined clockwise - positive indication

Talyvel® computer processing

Taylor Hobson optical analysis software 112-5105 (Optional)

A full Windows based software package is available to support Talyvel®, conforming to international standards BS817, DIN876, ISO8512. The package includes flatness measurement Union Jack (Moody) or grid, straightness measurement (including twist and squareness) and the polygon angular indexing program (for autocollimators).

The software can be accessed by means of an optional licensed dongle. Languages including Japanese and Chinese are also selectable.

Flatness program

Flatness can be measured using either Grid or Union Jack (Moody) methods. Simple, interactive menu driven software displays an initial diagram of the surface to be measured, together with surface generator lines and direction of measurement.

After the selected number of measuring steps have been entered, the program calculates and displays the shape of each generator line and the flatness of the surface.

Once the computer has accepted the Talyvel® readings, the values are displayed as arc seconds and then converted to height in micrometers or millionths of an inch units for printout.

Measurement results of flatness are displayed and printed out as an isometric diagram, certificate or results table. To comply with international standards a minimum zone calculation is used to generate flatness errors. A local variation gauge is available (code 112-5588).

Straightness & twist programs

The straightness program will permit straightness measurement on components such as machine tool slideways, shafts and rolls. The method used is similar to flatness measurement described above.

Results are presented in both tabular form and also as a straightness graph. Twist and squareness measurement is also available in this package. Analysis is to Least Squares Line or ENDS ZERO, with appropriate graphical representation of results.

The Twist program combines a single line straightness measurement with a number of radial or cross measurements.

Squareness & parallelism

Using the Right Angled Base (see accessories page 7) the Talyvel® can also be used to measure squareness. Two single straightness plots are taken (one at right angles to the other) and with each completed plot a slope value is given in mm/m. A comparison of these two values gives an indication of squareness.

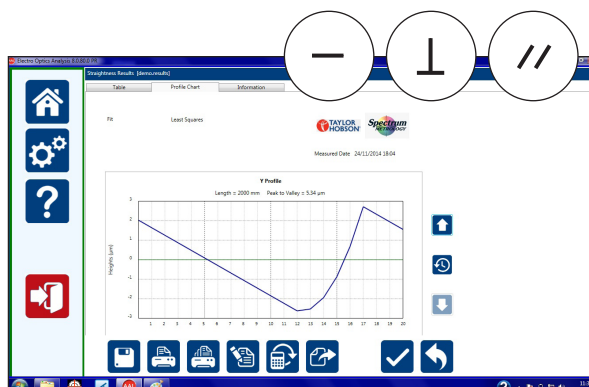
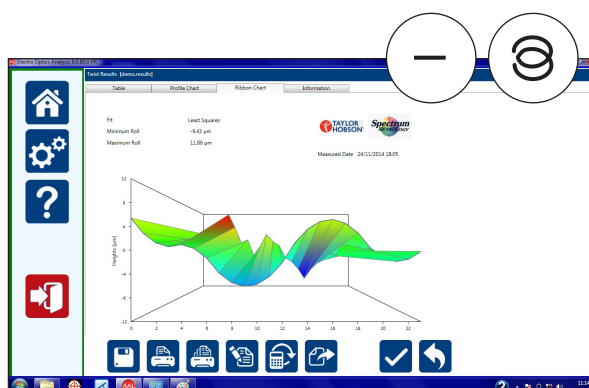
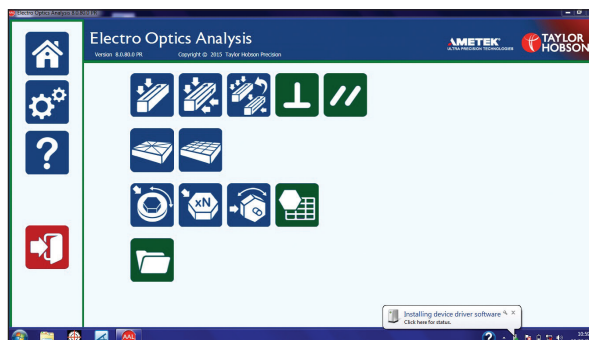

Special software – price on application

Additional software can be developed to meet specific application requirements upon request. A typical application is circular flatness and parallelism measurement, for example for measurement of large bearings where a series of measurements can be plotted around the circumference of each ring.

Talyvel® accessories

1 Basic adjustable base

This accessory can be set to the appropriate step interval length up to 200 mm (8 in) for flatness measurement by the “Grid” or “Union Jack” method and for straightness measurement. It provides a base for the Talyvel® 6 Level Unit with self aligning seating pads adjustable to a graduated scale.

The adjustable base is invaluable for setting different interval lengths when carrying out flatness checks on granite and iron surface tables. This base can also be used for mounting an autocollimator reflector.

code 112-5826

2 Adjustable base

As above, with tilt adjustment provided for setting the level unit to absolute horizontal.

code 112-2316

3 Block base

This 300 mm (12 in) long base allows the Level Unit to be positioned along cylindrical objects (eg for the measurement of mill rolls and shafting).

The block base has 120° vee bearing faces, all bearing faces are ground to a flatness within 2.5 µm (100 µin).

code 112-2314

4 Right angled base

Measurement of vertical surfaces is facilitated by this simplified version of the box frame which has the advantage of being much lighter.

All bearing faces are ground to a flatness within 2.5 µm (100 µin) and adjacent faces are square to within 10 seconds of arc (0.05 mm/metre 50 µin/in). A pair of 120° vee bearing faces are provided.

code 112-4583

Box frame

The box frame is useful for checking inverted or vertical surfaces.

code 112-2313

Other accessories such as extension leads, carrying cases and special bases are available on request.

5 Stride base

This accessory allows Talyvel® 6 or a bubble level to be mounted on the Taylor Hobson Micro Alignment Telescope to establish a truly horizontal line of sight.

code 112-2315

6 Basic tilt plate

A simple base with tilt adjustment with ± 3 degrees of tilt. Enables the user to apply a mechanical offset or tilt where the standard range is inadequate but a true level is not needed.

code 112-4950

Bubble vial

This robust bubble vial can be mounted on any of the accessory bases listed above in place of the Talyvel® Level Unit, to provide a simple, cost effective method of setting and checking angle and level.

It has a sensitivity of 10 seconds (0.05 mm/metre, 50 uin/in) per division.

Tilt adjustment for setting the Level Unit to absolute horizontal is provided for all these bases. A further adjustment for eliminating roll errors, which can be significant, is also included.

code 112-2318

Small angle generator

Users can calibrate their own Talyvel® instrument using a small angle generator. It consists of a beam which is pivoted at one end on rollers; the other end can be displaced a known amount.

The beam carries a small bed with adjustable vees for checking Talyvel®s or bubble vials. Can also be used for checking autocollimators.

code 137-1918

7 Local variation gauge

When carrying out Union Jack (Moody) measurements on larger surface tables, the operator has large triangular areas where no data is available. This gauge enables the user to make a more complete assessment. The data provided is then keyed into the 112-5105 software.

code 112-5588

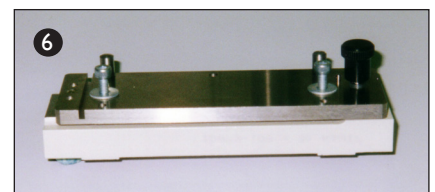
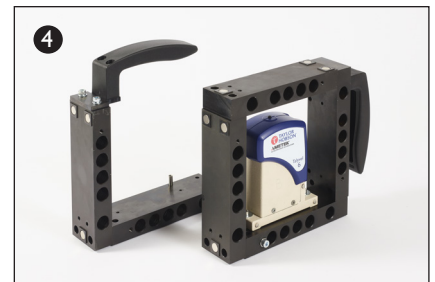
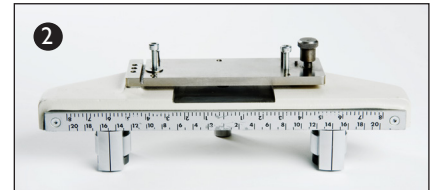
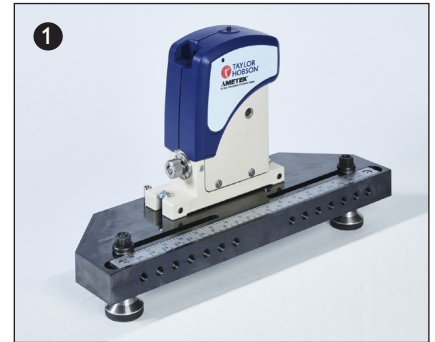

Equipment used

- M112-4515 - Talyvel® 6
- 112-2316 - Adjustable base (or 112-5826 base)
- 112-5105 - Software
- 112-4519 - Wireless dongle

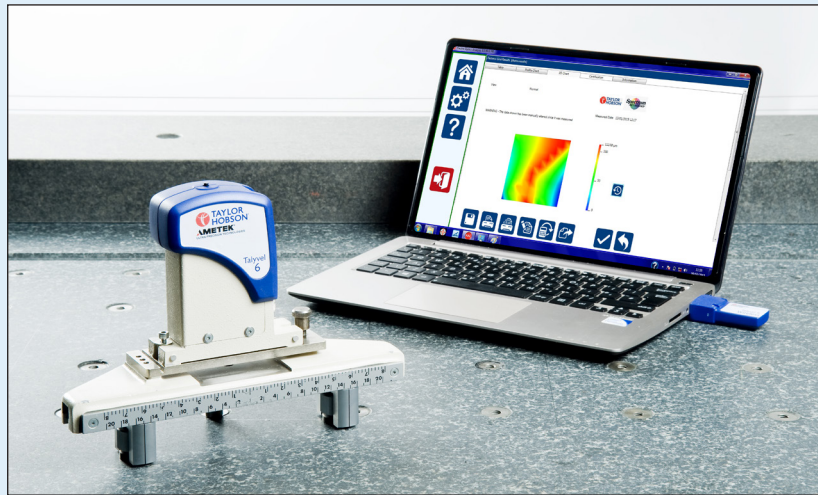

Application: flatness checks on granite and cast iron surface tables

Most manufacturers and users of surface tables require a fast method of flatness measurement.

The Talyvel® and optical analysis software reduces calibration time to a fraction of that taken by a skilled operator using unaided methods. Using the optical analysis software also reduces human error by automating calculations and giving printed hard copies and storage of calibration certificates.

Measurement procedure

Communication between computer and operator is in simple conversational language, enabling less experienced personnel to carry out surface table checks without difficulty. Each stage of measurement is prompted by the software, which also indicates when any error in operation has occurred.

The operator inputs the length and width of the table to be checked (the computer calculates the length of diagonal). The number of measuring steps to be taken over each generator is then selected. The computer calculates and displays step intervals in mm or inches over the length, width and diagonal of the table.

A guide line for the Talyvel® unit can now be marked out with these step intervals on the table along each generator, or alternatively a similarly marked straight edge can be used.

The adjustable base for Talyvel® is then set to the appropriate step interval length.

To measure the table, the Talyvel® level unit is stepped along each generator line at the predetermined points and each measurement taken by the software at the click of a button.

The computer will prompt the operator to change the step length, as necessary, before each generator is entered.

When all the generators are complete the departure from flatness is calculated. The individual values are printed out initially as arc seconds and then converted to the deviation from straightness in units of 0.001 mm or 0.0001 in. In addition, the printout gives the maximum deviation from flatness over the entire surface, and the closure errors over generators HF and EG. The measurement results are also graphed as an isometric diagram or a certificate and a measurement report can be generated and saved.

The grid method of flatness checking is similar in operation to the Union Jack above but with a grid pattern, by using a larger number of generators a more detailed analysis of a surface is given. Flatness measurements may be made using a minimum of only the four outside generators.

Application: straightness and twist measurement on machine tools

The Talyvel® can be used with the Taylor Hobson optical analysis software to check single axis straightness on machine tool rails (for dual axis straightness measurements the Taylor hobson autocollimator is used).

In many machine tool slide applications, the user may also want to measure the twist or roll of the machine slide – the Talyvel® can then be used together with the twist programme in the Taylor Hobson optical analysis software. First the straightness of the rail is measured followed by placing the Talyvel® at right angles to the rail and measuring the twist or roll along the rail at the same spacing points.



Application: Talyvel® ultra stability and sensitivity when checking level

The Talyvel® is a level based on a pendulum transducer and therefore is referenced to gravity, producing an absolute level to 0.2 seconds accuracy. This feature has given it many applications in the civil engineering field. Due to its well renowned sensitivity it has been used to monitor historic sites during renovation where there is a concern over structures collapsing. Examples include the Tower of Pisa, renovation of Milan Cathedral and the moving – brick by brick – of the Nuremburg railway station.

The Talyvel® is of course also used to set machine tool beds (or large structures such as astronomical telescopes) level and to gravity.



Application: using gravity as a reference for horizontal line

The Talyvel® produces a gravity reference which, when combined with the Taylor Hobson Micro Alignment Telescope, can produce a truly horizontal line or indeed a truly vertical line. An example of the use of a truly horizontal line would be the setting of rails horizontally where the rails need to carry precious fluids without spillage. An example of the use of a truly vertical line would be in the case of nuclear power refuelling rods.



Clinometers

Precision in angular measurement, checking and setting with 360° range

Highly Accurate TB100 Microptic Clinometers (code 142-43)

- Direct reading to 10 seconds of arc
- Estimation to within 2 seconds of arc
- Hardened ground steel base.

The TB100 Microptic Clinometer has been designed for simplicity and very high accuracy. The Clinometer uses a precisely divided circular glass scale, mounted on a spindle that rotates in a high quality bearing. At the end of the spindle is a sensitive bubble vial, which acts as a horizontal reference.

Dual purpose: In addition to functioning as a clinometer, the Microptic Clinometer can be used either vertically or horizontally as a circular measuring table. For this purpose the bubble unit is replaced by an optional worktable, which allows a maximum symmetrical load of 2.25 kg (5 lb). A reflector can also be fitted for use in conjunction with an autocollimator.

The field of view visible in the eyepiece contains two scales. The lower one is the main scale, in degrees with 10 minute sub-divisions; above it is the scale of the optical micrometer, in minutes with 10 sub-divisions.

A variety of accessories are available on request, including:

Worktable

Interchangeable with the bubble unit, enabling small components to be attached to the clinometer spindle.

Table diameter is 120 mm (4.75 in). With the clinometer horizontal, the table will carry a symmetrically placed maximum load of 2.5 kg (5 lb).

Adjustable reflector (code 112-5589)

Replaces the bubble unit to enable the clinometer to be used with an autocollimator for setting-out angles.

Electric Illuminator

For use in poor ambient lighting conditions or when the clinometer is used horizontally. It has a 6.5V, 2W lamp (Code 242-103) and replaces the clinometer mirror.

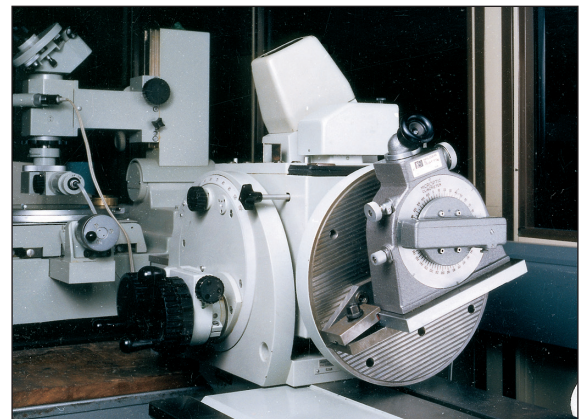

TB100 checking dividing head

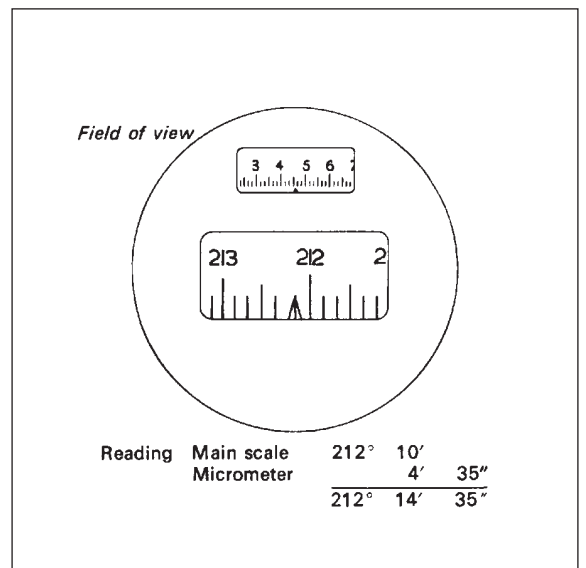

TB100 eyepiece field of view

Digital Inclinometer (code 137-2165-02)

- Absolute/relative measurement
- Selectable measurement mode: radian/angle/mm
- Built in rechargeable batteries
- Alarm setting for fast 'GO' / 'NO GO' measurements
- Auto temperature drift compensation.

This single axis digital clinometer is designed for stability and repeatability in a range of applications. Handheld and easy to use, this workshop clinometer uses quartz accelerometer, giving fast and accurate data. The design uses a box frame where angles can be measured from each of the 4 faces and comes as standard with 2 magnetic sides. Two versions are available with $\pm 45^\circ$ or $\pm 15^\circ$ range.



The clinometer can be used with a USB cable and send measured results directly to a PC or in wireless mode up to a distance of 10 metres. An angular limit can be preset, giving an immediate audible alert if the component being measured is out of specification.

Applications

Measuring and checking

- Angular faces
- Droop of helicopter blades
- Relief angles on large cutting tools
- Jigs and fixtures
- Checking artillery barrel angle
- Inclination tables on jig boring machines
- Angular work on grinding and lapping machines
- Checking angular indexing heads and tables



Technical data - Clinometers

Type	Workshop digital (code 137-2165)	Workshop digital (code 112-5832)	High precision TB100 (code 142-43)
Angular range	$\pm 45^\circ$	$\pm 15^\circ$	0-360°
Max permissible error between any 2 readings shall not exceed	2 min*	30 seconds	10 seconds
Dimensions (L x W x H)	107 x 27 x 75 mm	107 x 27 x 75 mm	165 x 76 x 215 mm
Weight	300 g	300 g	3.4 kg (7.5 lb)

* Best accuracy 30 sec over reduced 1 degree range.

UKAS Certification

Clinometers can be supplied with a United Kingdom Accreditation Service (UKAS) certificate which gives an independent and authoritative traceable guarantee of instrument performance and accuracy. Regular servicing and UKAS calibration will guarantee that the performance specification is maintained.

Spectrum metrology

Electro-optical measurement customers often require advice on solving a specific manufacturing or calibration problem. With many years experience in electro-optical metrology, Spectrum Metrology provides rapid technical and application support via phone, e-mail or on-site visits. Full demonstration and training is available either on-site or in Spectrum Metrology's demonstration room.

Spectrum Metrology is also the authorised repair agent to Taylor Hobson for the electro optical metrology range and holds a wide stock of ex-demonstration equipment for hire or sale.

www.spectrum-metrology.co.uk

Electro optical metrology

Taylor Hobson has been selling electro-optical metrology products since the late 1930s and the range includes Micro Alignment Telescopes (used for checking and setting straightness and alignment) Autocollimators (for accurate measurement of small angular displacements), clinometers and "Talyvel" electronic levels. Used in a range of applications in industries such as machine tools, aerospace, marine and steel rolling, the Taylor Hobson range combines high accuracy and repeatability with fast response and operational convenience.

To provide focused technical support to all its electro-optical metrology customers, Taylor Hobson has a dedicated technical support centre.

Spectrum Metrology can be contacted on:

Email: sales@spectrum-metrology.co.uk

Tel: +44 (0) 116 276 6262

Address: Unit 8 Ireton Avenue, Leicester, LE4 9EU, England, UK.



© Taylor Hobson Ltd. 2019



Taylor Hobson UK

(Global Headquarters)

PO Box 36, 2 New Star Road
Leicester,
LE4 9JQ,
England

Tel: +44 (0)116 276 3771
taylor-hobson.sales@ametek.com



Taylor Hobson France

Rond Point de l'Épine Champs

Batiment D, 78990 Elancourt, France

Tel: +33 130 68 89 30
taylor-hobson.france@ametek.com



Taylor Hobson Germany

Rudolf-Diesel-Straße 16,
D-64331 Weiterstadt, Germany

Tel: +49 6150 543 0
taylor-hobson.germany@ametek.com



Taylor Hobson Italy

Via Della Liberazione 24, 20068, Peschiera
Borromeo, Zelofoaramagno, Milan, Italy

Tel: +39 02 946 93401
taylor-hobson.italy@ametek.com



Taylor Hobson India

Divyasree NR Enclave, 4th Floor, Block A,
Plot No. 1, EPIP Industrial Area, Whitefield,
Bengaluru - 560066, India

Tel: +91 80 6782 3346
taylor-hobson.india@ametek.com



Taylor Hobson China

taylor-hobson-china.sales@ametek.com

Shanghai Office

Part A1, A4, 2nd Floor, Building No. 1, No. 526
Fute 3rd Road East, Pilot Free Trade Zone,
Shanghai, 200131, China

Tel: +86 21 5868 5111-110

Beijing Office

Western Section, 2nd Floor, Jing Dong Fang
Building (B10), No. 10, Jiu Xian Qiao Road,
Chaoyang District, Beijing, 100015, China

Tel: +86 10 8526 2111

Chengdu Office

No. 9-10, 10th floor, 9/F, High-tech Incubation
Park, No. 160, Jinyue West Road, Chengdu
610041, China

Tel: +86 28 8675 8111

Guangzhou Office

Room 810 Dongbao Plaza, No.767 East
Dongfeng Road, Guangzhou, 510600, China

Tel: +86 20 8363 4768



Taylor Hobson Japan

3F Shiba NBF Tower; 1-1-30, Shiba Daimon
Minato-ku, Tokyo 105-0012, Japan

Tel: +81 34400 2400
taylor-hobson.japan@ametek.com



Taylor Hobson Korea

#309, 3rd FL, Gyeonggi R&DB Center; 105,
Gwanggyo-ro, Yeongtong-gu, Suwon-si,
Gyeonggi-do, Korea, 16229

Tel: +82 31 888 5255
taylor-hobson.korea@ametek.com



Taylor Hobson Singapore

AMETEK Singapore, 10 Ang Mo Kio Street 65,
No. 05-12 Techpoint, Singapore 569059

Tel: +65 6484 2388 Ext 120
taylor-hobson.singapore@ametek.com



Taylor Hobson Thailand

89/45, Moo 15, Enterprise Park, Bangna-Trad
Road, Tambol Bangkaew, Amphur Bangplee,
Samutprakarn Province 10540, Thailand

Tel: +66 2 0127500 Ext 505
taylor-hobson.thailand@ametek.com



Taylor Hobson Taiwan

10F-5, No.120, Sec. 2, Gongdao Wu Rd.,
Hsinchu City 30072, Taiwan

Tel: +886 3 575 0099 Ext 301
taylor-hobson.taiwan@ametek.com



Taylor Hobson Mexico

Acceso III No. 16 Nave 3 Parque Ind. Benito
Juarez Queretaro, Qro. Mexico C.P. 76120

Tel: +52 442 426 4480
taylor-hobson.mexico@ametek.com



Taylor Hobson USA

27755 Diehl Road, Suite 300, Warrenville,
IL 60555, USA

Tel: +1 630 621 3099
taylor-hobson.usa@ametek.com



1100 Cassatt Road, Berwyn, PA 19312, USA
Email: info.corp@ametek.com
Web: www.ametek.com